

Pametni krmilnik za nadzor sobne temperature Navilink A59

kat. št. 074208

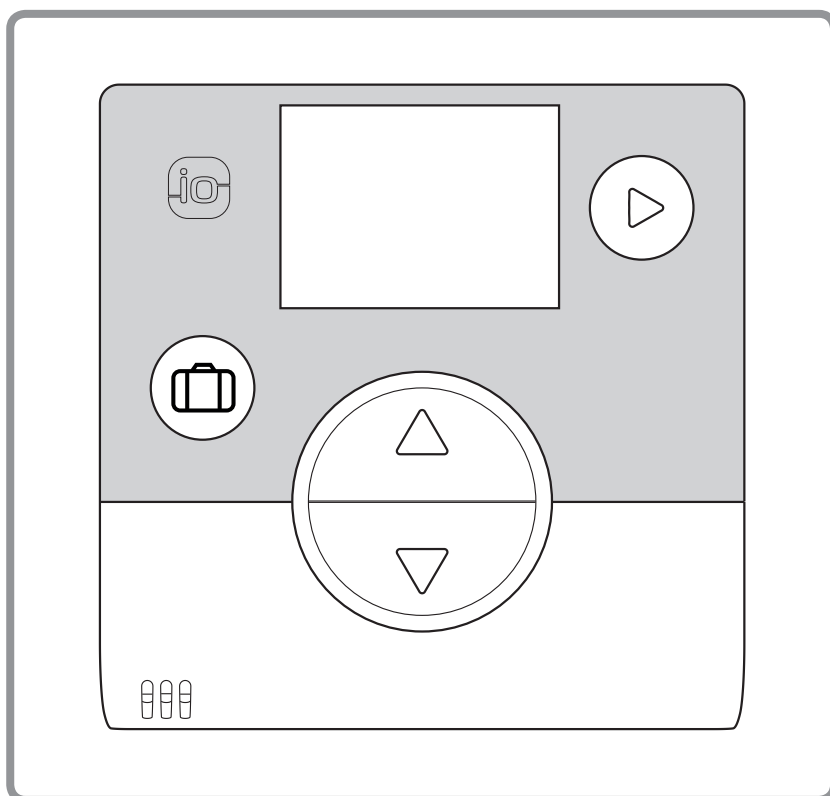

 **atlantic**

SL

Priročnik št. 1846-5
06. 12. 2017

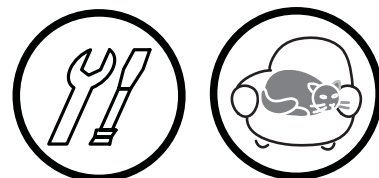

Referenčni priročnik

za strokovnjake

in uporabnike,

ki ga uporabnik hrani
za morebitne potrebe
v prihodnje.

atlantic-comfort.com

Vsebina

Opis opreme	2
Splošne značilnosti 2	Opis zaslona. 3
Montaža in povezave	4
Namestitev. 4	Uporaba tipala z omrežnim napajanjem 5
Odprtje tipala 4	Pritrditev na steno 5
Uporaba tipal s polnilniki. 4	
Wi-Fi povezava	7
Osnovni koraki za povezovanje sobnih tipal. 7	Povezovanje 2. tipala 10
Povezovanje tipala s toplotno črpalko/kotlom 8	
Meni za nameščanje	12
Umerjanje 13	Prejem ključa io-homecontrol® 17
Povezovanje tipala 14	Različica 18
Ponastavitev. 15	Postopek povezovanja 19
Pošiljanje ključa io-homecontrol® 16	
Način uporabe	20
Nastavitev vrednosti preko naprednega menija:	Način odsotnosti. 21
Ročni način 20	
Nastavitev vrednosti preko enostavnega menija:	
Neposredna nastavitvena vrednost 20	
Seznam napak	22

1 Opis opreme

1.1 Splošne značilnosti

Frekvenca: 868 MHz.

Radiofrekvenčna moč: največ 5 mW.

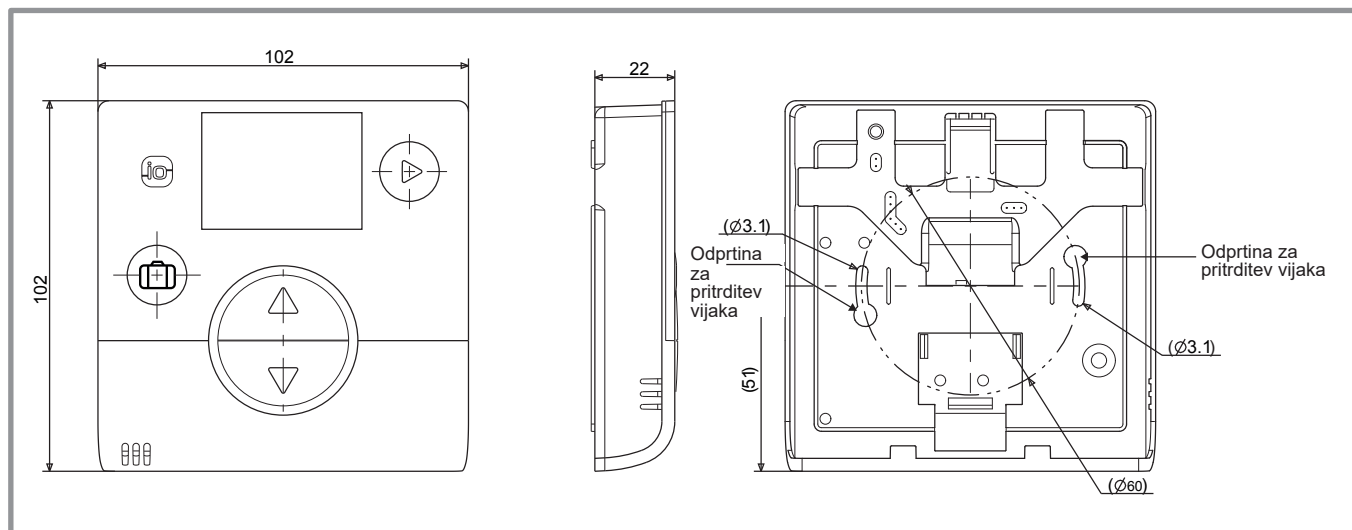

slika 1 - Mere v mm

1.2 Opis zaslona

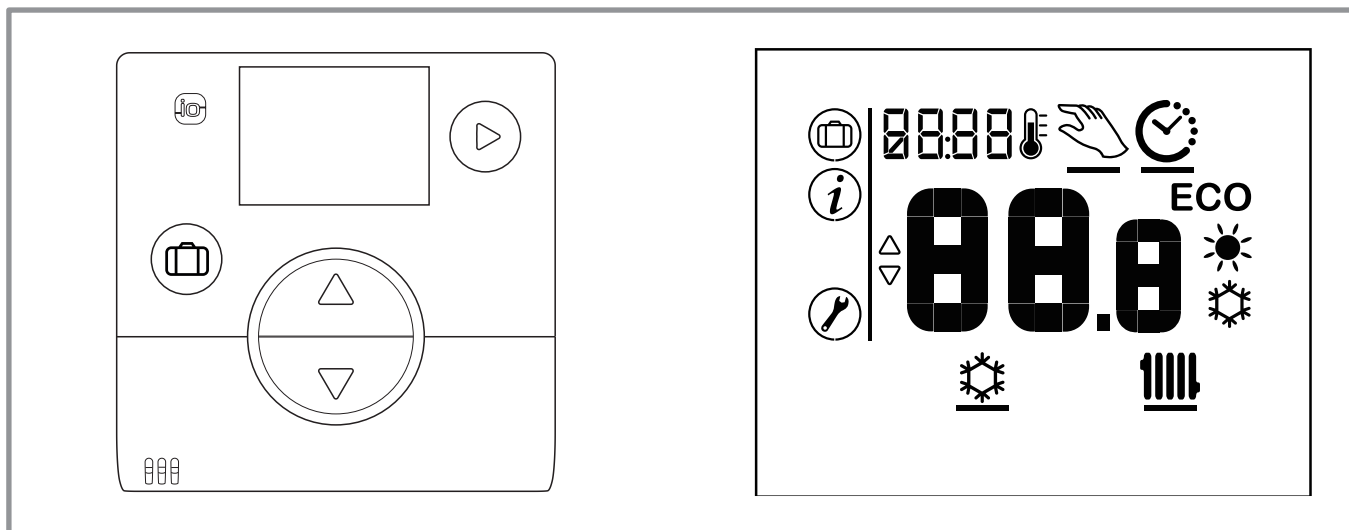

Lastnosti



- Način odsotnosti



- Navigacija
- Sprememba način (Izklop; Ogrevanje, Hlajenje)



- Povečajte nastavljeno vrednost.
- Pojdite na naslednji zaslon



- Zmanjšajte nastavljeno vrednost
- Nazaj na prejšnji zaslon

Simboli Definicije



- Način odsotnosti omogočen



- Informacije



- Meni za nameščanje



- Način hlajenja*



- Način ogrevanja



- Način za Udobje hlajenja omogočen*



- Način za Udobje ogrevanja omogočen

ECO • Varčni način za ogrevanje/hlajenje omogočen



- Način za časovni program



- Ročni način

00.0

- Nastavljena vrednost

21.7°C

- Ohranjevalnik zaslona/Okoljska temperatura

* Če vgradnja to omogoča

2 Montaža in povezave

2.1 Namestitev

Tipalo mora biti nameščeno v območju dnevne sobe na nezakriti strani stene. Vgrajeno mora biti tako, da omogoča prosti dostop. Izberite lokacijo s čim manj ovirami za brezhibnem prenos signalov. Ravnjajte v skladu z naslednjimi točkami:

- Izogibajte se bližini električnih kablov, močnim magnetnim poljem ali napravam, kot so računalniki, televizorji ali mikrovalovne pečice ipd.
- Izogibajte se področjem motenj, ki jih povzročijo večji kovinski predmeti ali zgradbe, ki vsebujejo fino kovinsko mrežo ali ojačitev (npr. steklo ali specialni beton).
- Oddaljenost med oddajnikom in sprejemnikom ne sme presegati 30 m oziroma 2 nadstropij.
- Naprave ne nameščajte v notranjost kovinskega ohišja (npr. toplotne črpalke).

- Izognite se neposrednemu viru toplote (dimnik, televizor, kuhalne površine, sonce) in zračnim območjem (prezračevanje, vrata itd.)

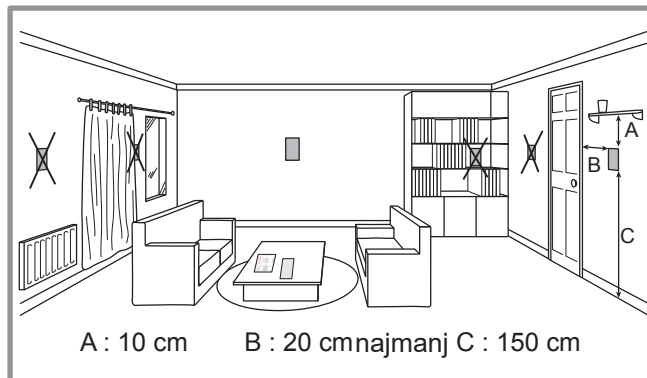

2.2 Odprtje tipala

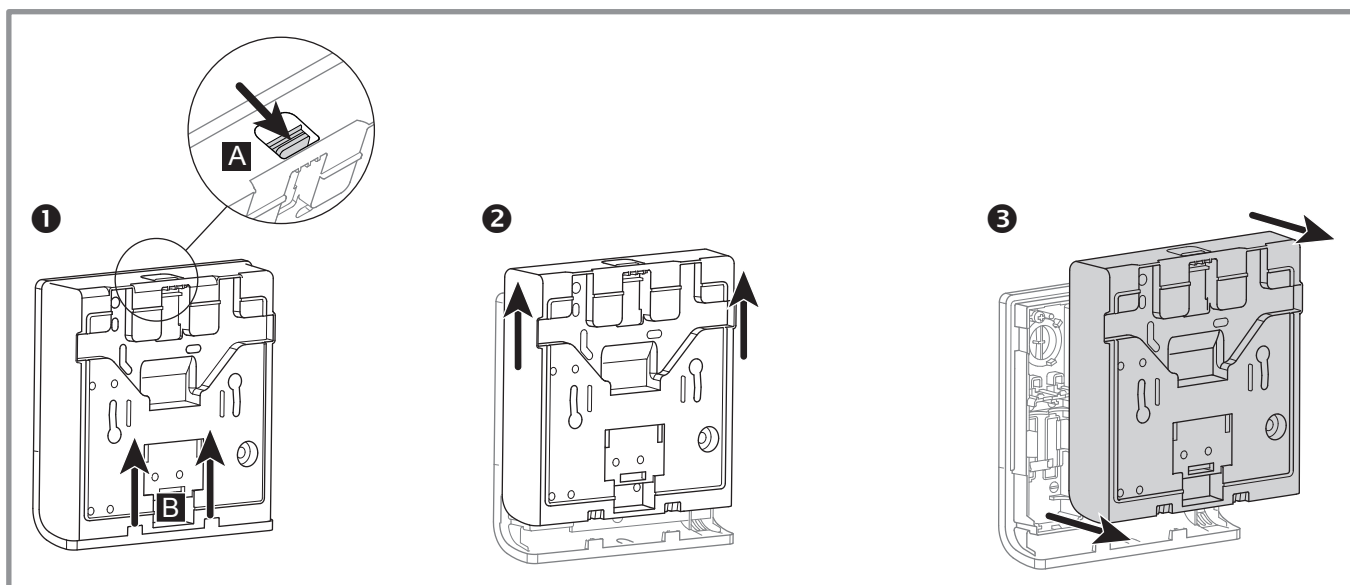

slika 2 - Odprtje tipala

2.3 Uporaba tipal s polnilniki

2 bateriji AA LR03 (priloženi).

Ohranite polariteto.

☞ **Ne povezujte žičnih vodov.**



Tveganje za predčasno izrabo baterij, če se generator izprazni.

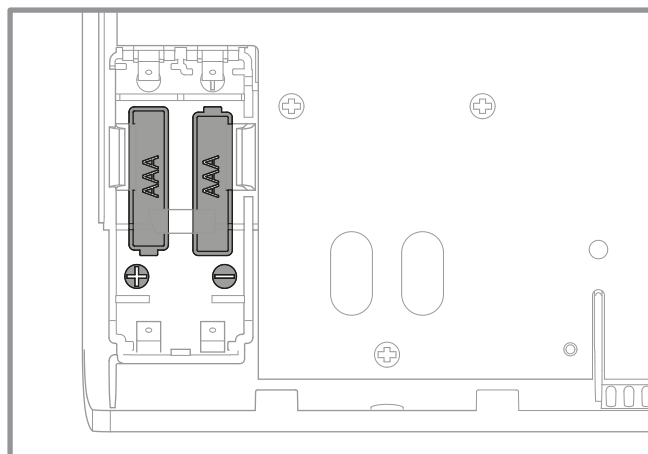

slika 3 - Z baterijo napajano tipalo

2.4 Uporaba tipala z omrežnim napajanjem

Nazivna moč 12 - 24V DC.

Vrsta uporabljenega kabla: 0,5 do 1,5 mm² togi kable ali 0,5 do 0,75 mm² upogljiv kable s togim koncem.

- ☞ **Ne uporabljajte baterij/polnilnikov.**
- ☞ **Ni združljivo z Naia/Naema.**

2.4.1 Kabelska povezava

1. Olupite končnik žičnega voda v dolžini okrog 10 mm.
2. Končnika kabla vstavite v terminalni priključek (potisni konektorji).

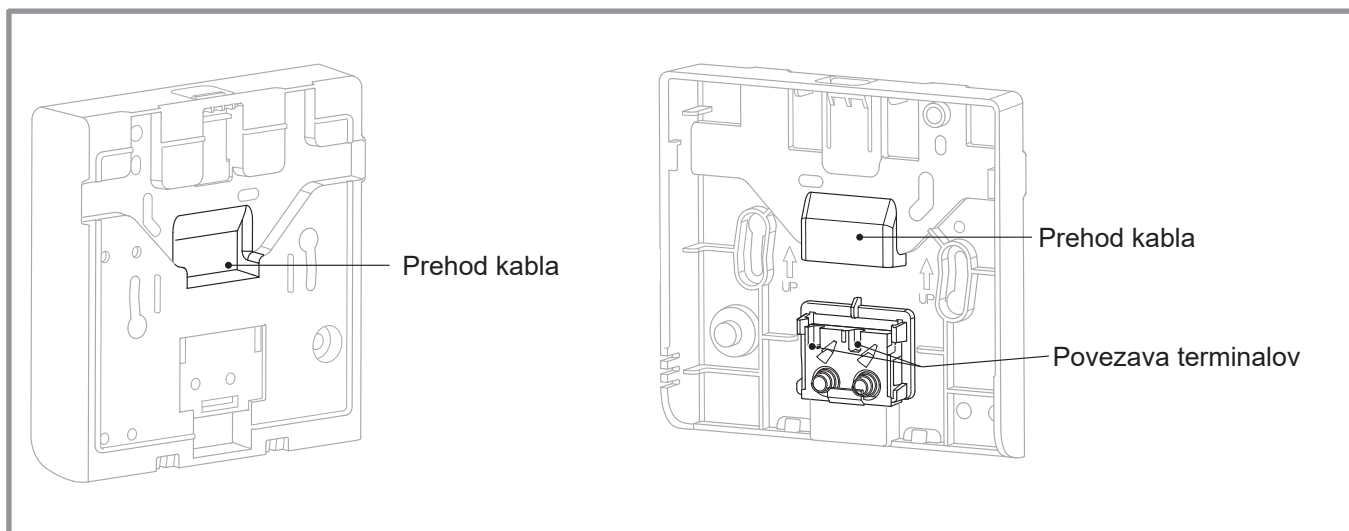

slika 4 - Kabelska povezava

2.4.2 Odklop kablov

Uporabite ploščat izvijač.

Malo kovinsko ploščico sukajte, medtem ko vlečete kabel.

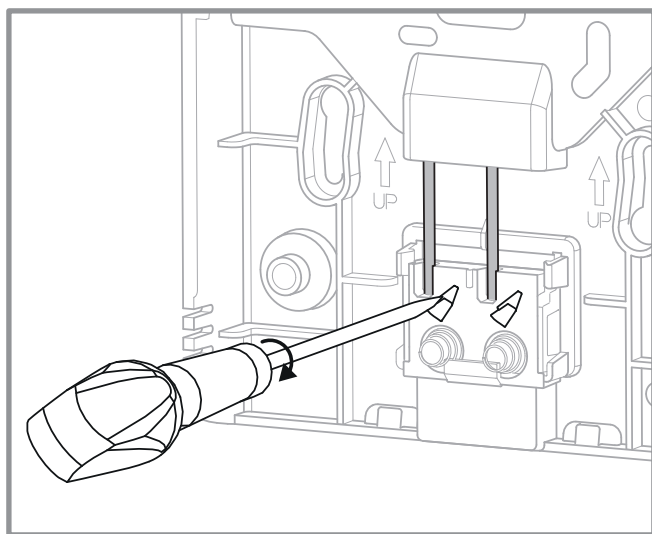

slika 5 - Odklop kablov

2.5 Pritrditev na steno

Zadnjo ploščico tipala pritrdite s pomočjo vijakov (niso priloženi).

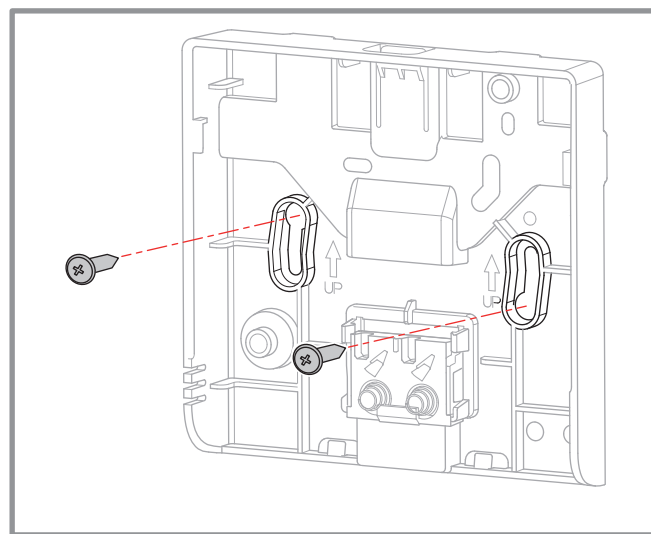

slika 6 - Pritrditev na steno



3 Wi-Fi povezava

3.1 Osnovni koraki za povezovanje sobnih tipal

- Toplotna črpalka/kotel--> 1 sobno tipalo

Tipalo povežite s toplotno črpalko/kotlom.

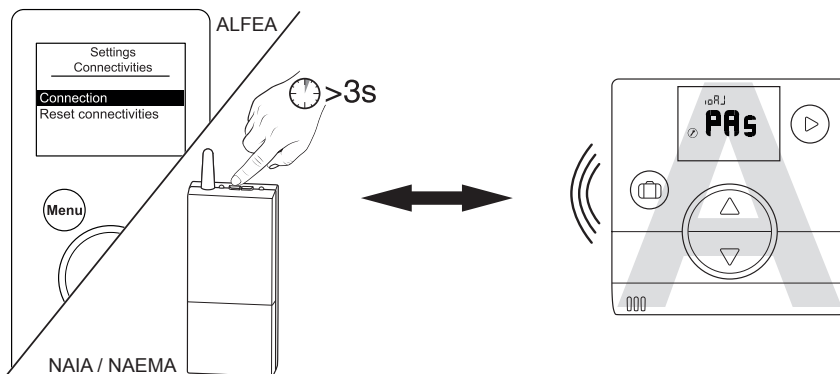

(glej "Postopek povezovanja ...", stran 19)

- Toplotna črpalka/kotel--> 2 sobni tipali

1. tipalo povežite s toplotno črpalko/kotlom.

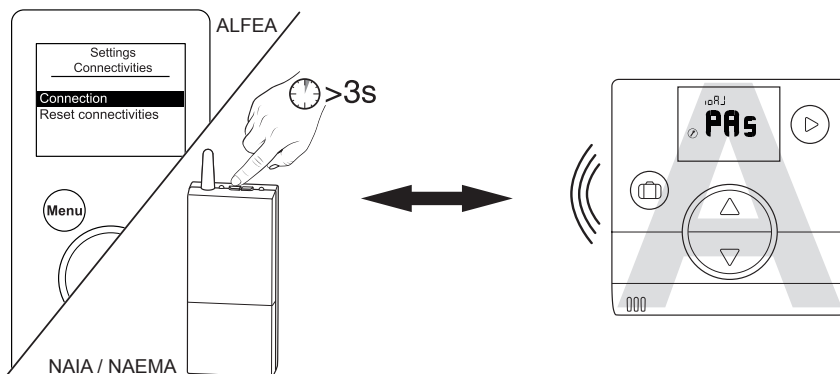



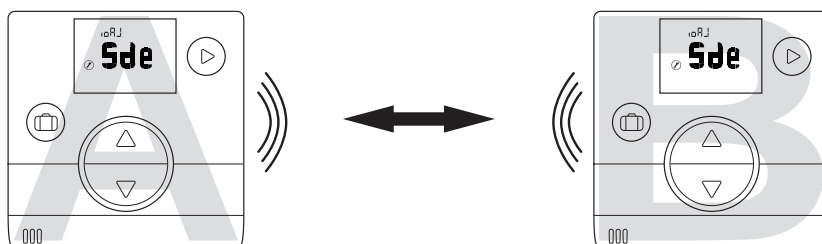







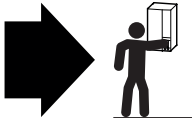

2. tipalo povežite s 1. tipalom.

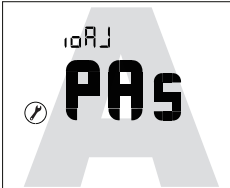

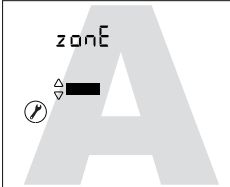
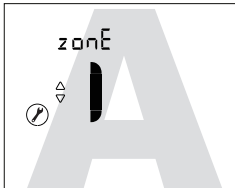
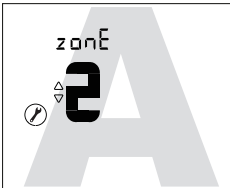
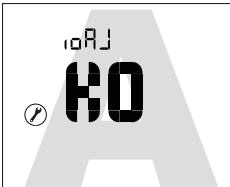
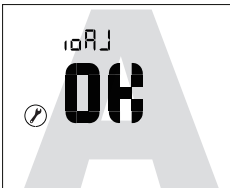



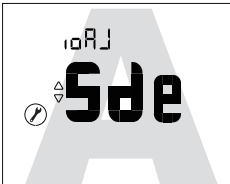

- ☞ Za povezovanje dveh naprav (toplotna črpalka-tipalo ali tipalo-tipalo) morata biti obe napravi v načinu za povezovanje.

3.2 Povezovanje tipala s toplotno črpalko/kotlom

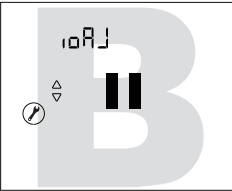
3.2.1 Povezovanje 1. tipala s toplotno črpalko/kotlom

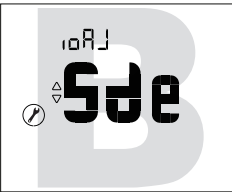
Ukrep	Opis	Zaslon
1	<p>Začnite s postopkom povezovanja na kotlu ali toplotni črpalki.</p> <p>Zgledujte se po navodilih, ki so priložena izdelku, ali "Postopek povezovanja ...", stran 19.</p>	
2	 <p>Privzeti zaslon, ko se vzpostavi začetno delovanje tipala.</p>	
3	<p>Izberite »PAs« s pomočjo gumbov  in .</p> <p>Počakajte 5 sekund.</p> <p>»PAs« utripa. Tipalo čaka na uparitev 10 minut.</p>	
4	<p>Izberite številko področja tipala s pomočjo gumbov  in .</p> <p>Počakajte 5 sekund.</p>	  <p style="text-align: center;">ali</p> 
	<p>Povezovanje ni uspelo.</p> <p>Postopek ponovite od 2. koraka dalje.</p>	
5	<p>Povezovanje je uspelo.</p>	
6	<p>Če je treba povezati le eno tipalo</p> <p>Izberite »Fl n« (konec) s pomočjo gumbov  in .</p>	
	<p>Če je treba povezati še 2. tipalo</p> <p>Izberite »Sde« (tipalo) s pomočjo gumbov  in .</p> <p>»Sde« utripa. Tipalo čaka na uparitev 10 minut.</p>	

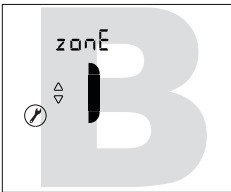
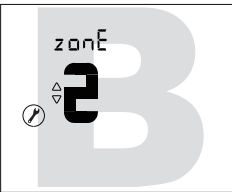
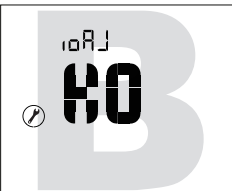
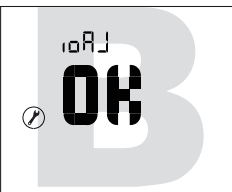
3.2.2 Povezovanje 2. tipala

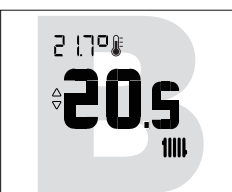
Ukrep	Opis	Zaslon
1	Začnite s postopkom povezovanja 1. tipala. Uporabite naslednji postopek za povezovanje 2. tipala.	
2	 Privzeti zaslon, ko se vzpostavi začetno delovanje tipala.	
3	Izberite »Sde« (tipalo) s pomočjo gumbov  in  . Počakajte 5 sekund. »Sde« utripa. Tipalo čaka na uparitev 10 minut.	
4	Izberite številko področja tipala s pomočjo gumbov  in  . Počakajte 5 sekund.	 ali 
5	Povezovanje ni uspelo. Postopek ponovite od 2. koraka dalje.	
6	Povezovanje je uspelo.	
6	Pojdite nazaj na glavni zaslon s pomočjo gumba  . V primeru neuspeha ponovno zaženite postopek od začetka.	 













3.3 Povezovanje 2. tipala

Namestitev vključuje 1. delujoče tipalo.

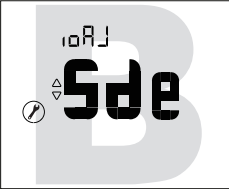

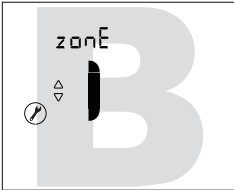
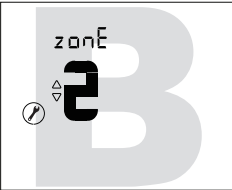
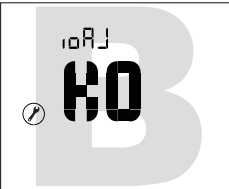
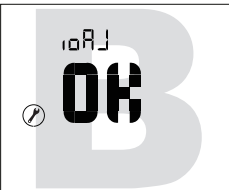
3.3.1 Postopek povezovanja s 1. tipalom

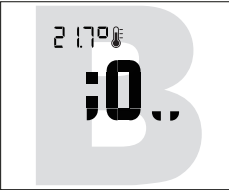
Ukrep	Opis	Zaslon
1	Vstopite v meni za nameščanje tako, da hkrati pritisnete  in  za 3 sekunde.	
2	Izberite »ioAJ« s pomočjo gumba  .	
3	Izberite »oui« (da) s pomočjo gumbov  in  . Počakajte 5 sekund.	
4	»Sde« (tipalo) utripa. Tipalo čaka na uparitev 10 minut.	
5	 Začnite s postopkom povezovanja 2. tipala (" Povezovanje 2. tipala ", stran 11).	
6	Povezovanje je uspelo.	
6	Povezovanje ni uspelo.	
7	Izberite »Fln« (konec) s pomočjo gumbov  in  .	



3.3.2 Povezovanje 2. tipala

Ukrep	Opis	Zaslon
1	Začnite s postopkom povezovanja 1. tipala. Uporabite naslednji postopek za povezovanje 2. tipala.	
2	 Privzeti zaslon, ko se vzpostavi začetno delovanje tipala.	
3	Izberite »Sde« (tipalo) s pomočjo gumbov  in  . Počakajte 5 sekund. »Sde« utripa. Tipalo čaka na uparitev 10 minut.	
4	Izberite številko področja tipala s pomočjo gumbov  in  . Počakajte 5 sekund.	 ali 
5	Povezovanje ni uspelo. Postopek ponovite od 2. koraka dalje.	
6	Povezovanje je uspelo.	
6	Pojdite nazaj na glavni zaslon s pomočjo gumba  . V primeru neuspeha ponovno zaženite postopek od začetka.	  

4 Meni za nameščanje







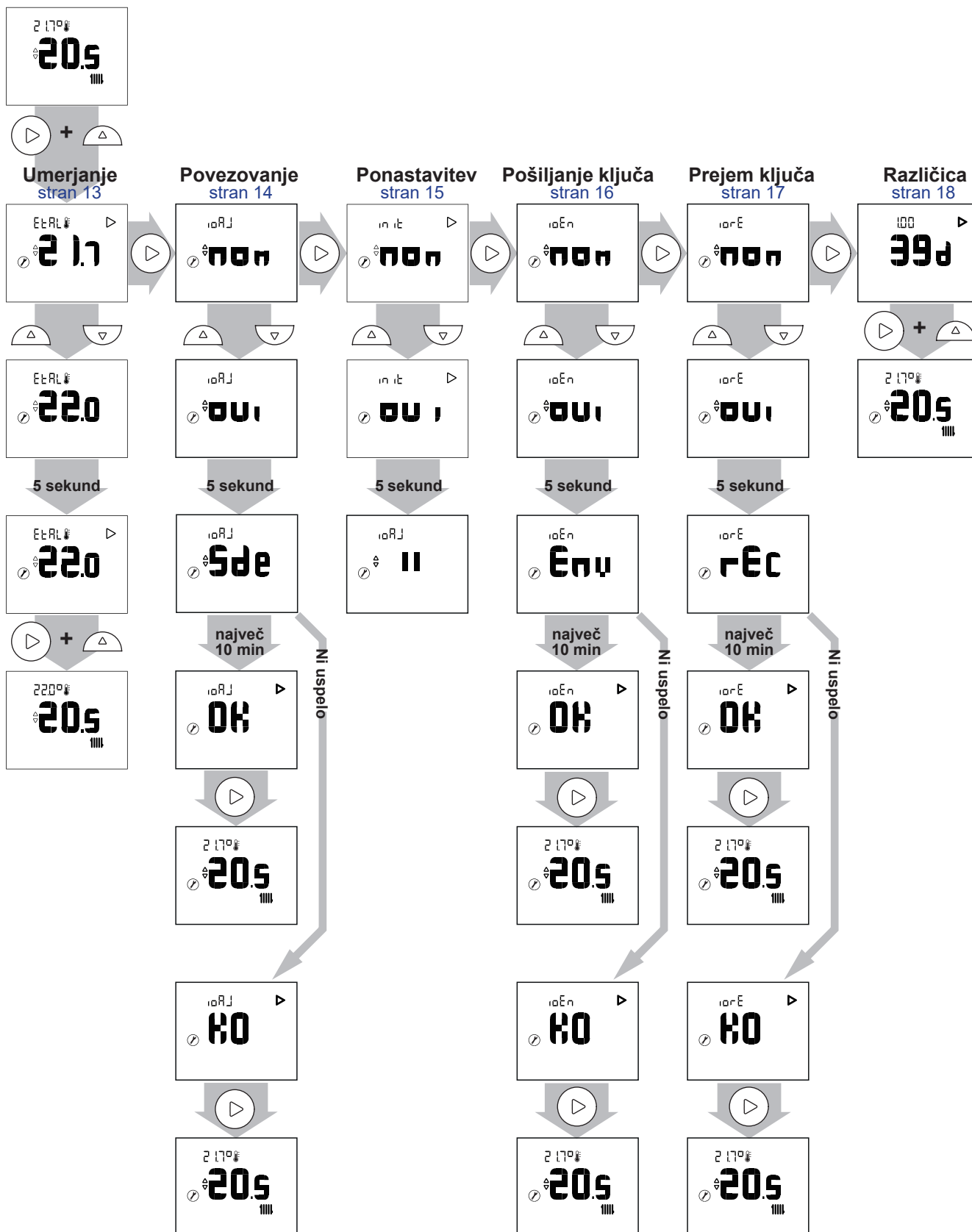



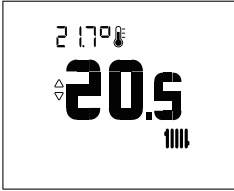

Vstopite v meni za nameščanje tako, da hkrati pritisnete  in  za 3 sekunde.

Ko je omogočen Meni za nameščanje, se prikaže simbol .



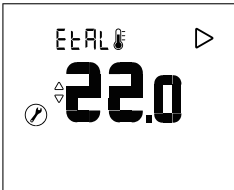





Zapustite meni za nameščanje tako, da hkrati pritisnete  in  za 3 sekunde.



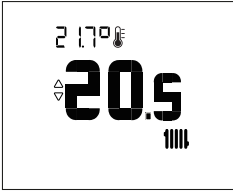



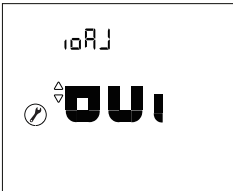
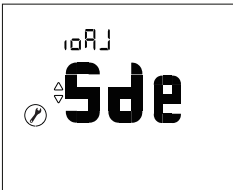
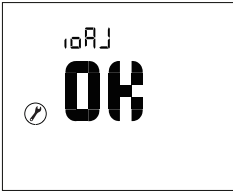
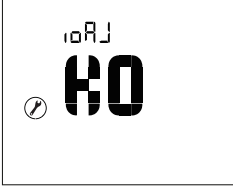



4.1 Umerjanje

Ukrep	Opis	Zaslon
1	Vstopite v meni za nameščanje tako, da hkrati pritisnete  in  za 3 sekunde.	
2	Izberite »EtAl« (umerjanje) s pomočjo gumba  .	
3	Nastavite temperaturo s pomočjo gumbov  in  . Počakajte 5 sekund.	
4	Tipalo je umerjeno.	
5	Zapustite meni za nameščanje tako, da hkrati pritisnete  in  za 3 sekunde.	

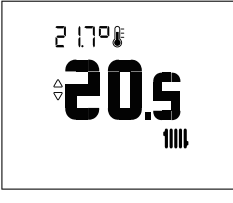
4.2 Povezovanje tipala

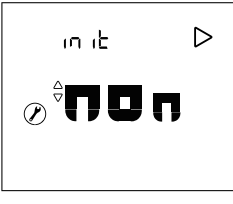
Ukrep	Opis	Zaslon
1	Vstopite v meni za nameščanje tako, da hkrati pritisnete  in  za 3 sekunde.	
2	Izberite »ioAJ« s pomočjo gumba  .	
3	Izberite »oui« (da) s pomočjo gumbov  in  . Počakajte 5 sekund.	
4	»Sde« (tipalo) utripa. Tipalo čaka na uparitev 10 minut.	
5	Povezovanje je uspelo.	
	Povezovanje ni uspelo.	
6	Pojdite nazaj na glavni zaslon s pomočjo gumba  . V primeru neuspeha ponovno zaženite postopek od začetka.	

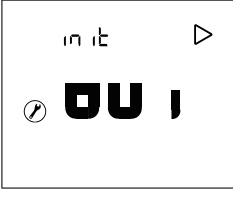
4.3 Ponastavitev

Ukrep	Opis	Zaslon
1	Vstopite v meni za nameščanje tako, da hkrati pritisnete  in  za 3 sekunde.	
2	Izberite »init« (ponastavitev) s pomočjo gumba  .	
3	Izberite »oui« (da) s pomočjo gumbov  in  . Počakajte 5 sekund.	
5	Tipalo je ponastavljeno.	

• NAPREDNI PARAMETRI – MOŽNOSTI PAMETNIH SISTEMOV ZA DOM













Varnostni ključ

Protokol io-homecontrol® WiFi ima vgrajeno varnost, ki onemogoča interferenco z opremo v bližini. V področju, kjer se uporablja več naprav io-homecontrol®, bo prva vgrajena naprava ustvarila edinstveni »varnostni ključ« za vse naprave v zgradbi. Obstoječa oprema bo ta varnostni ključ delila z drugo, kasneje dodano opremo.



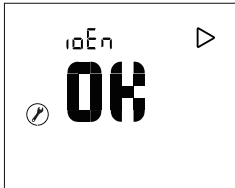





To poglavje je namenjeno usposobljenim uporabnikom tehnologije io-homecontrol® in ponuja različne storitve, ki jih pokriva ta ključ.

Zgledujte se po poglavju o povezovanju naprav io-homecontrol®.



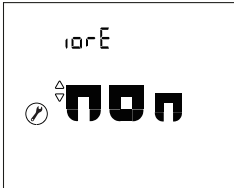

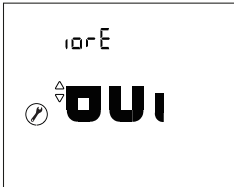
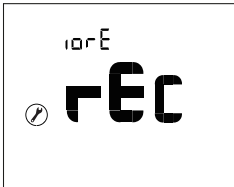
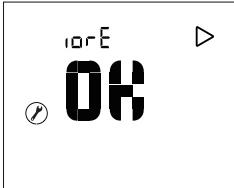
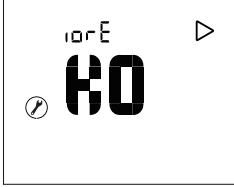



4.4 Pošiljanje ključa io-homecontrol®

Ukrep	Opis	Zaslon
1	Vstopite v meni za nameščanje tako, da hkrati pritisnete  in  za 3 sekunde.	
2	Izberite »ioEn« s pomočjo gumba  .	
3	Izberite »oui« (da) s pomočjo gumbov  in  . Počakajte 5 sekund.	
4	Začne se pošiljanje zaporedja ključa io-homecontrol®.	
5	Ključ io-homecontrol® je bil uspešno poslan.	
	Ključ io-homecontrol® ni bil odposlan.	
6	Pojdite nazaj na glavni zaslon s pomočjo gumba  . V primeru neuspeha ponovno zaženite postopek od začetka.	

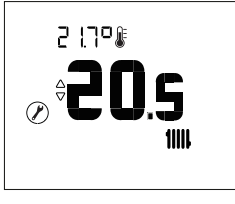
4.5 Prejem ključa io-homecontrol®

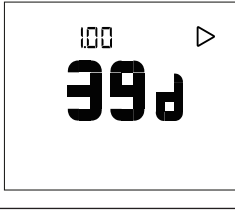
Ukrep	Opis	Zaslon
1	Vstopite v meni za nameščanje tako, da hkrati pritisnete  in  za 3 sekunde.	
2	Izberite »iorE« s pomočjo gumba  .	
3	Izberite »oui« (da) s pomočjo gumbov  in  . Počakajte 5 sekund.	
4	Začne se prejem zaporedja ključa io-homecontrol®.	
5	Ključ io-homecontrol® je bil uspešno prejet.	
	Ključ io-homecontrol® ni bil prejet.	
6	Pojdite nazaj na glavni zaslon s pomočjo gumba  . V primeru neuspeha ponovno zaženite postopek od začetka.	

4.6 Različica

Ukrep	Opis	Zaslon
1	Vstopite v meni za nameščanje tako, da hkrati pritisnete  in  za 3 sekunde.	
2	Vstopite v zaslon »Različica« s pomočjo gumba  .	
3	Zapustite meni za nameščanje tako, da hkrati pritisnete  in  za 3 sekunde.	

4.7 Postopek povezovanja ...

4.7.1 ... s toplotno črpalko Alféa A.I.

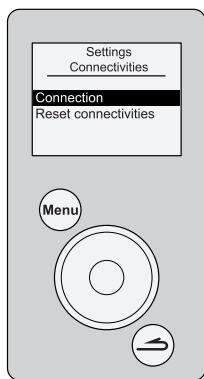

Za povezavo sobnega senzorja pojdite v meni:

»Nastavitve« > »Povezljivost« > »Povezava«.

Naprava čaka na uparitev 10 minut.

☞ **Meni »Povezava« ni več na voljo, če je bilo povezovanje tipala že opravljeno.**



Za podrobnejše informacije se zgledujte po navodilih, ki so priložena napravi.

4.7.2 ...z Navipass io-homecontrol®

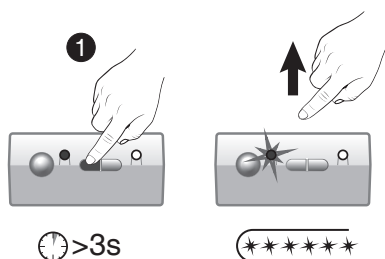

NAVIPASS IO nastavite na čakanje za povezovanje.

Pritisnite ključ 1 za 3 sekunde.

Sprostite.





LED 1 hitro utripa v zeleni barvi.

Za podrobnejše informacije se zgledujte po navodilih, ki so priložena napravi Navipass io-homecontrol®.

5 Način uporabe

5.1 Nastavitev vrednosti preko naprednega menija: Ročni način

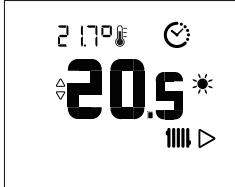

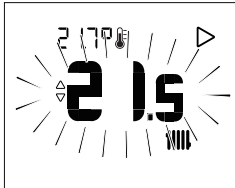
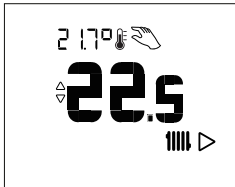



☞ Izjema (odstopanje od programa) vam omogoča spremembo nastavljene vrednosti za obdobje 24 ur.

Ukrep	Opis	Zaslona
1	Pritisnite  ali  .	
2	Nastavljena vrednost utripa. Nastavite vrednost s pomočjo gumbov  in  .	
3	Ko je nastavitvena vrednost izbrana, počakajte 5 sekund. Vrednost preneha utripati. Sprememba nastavljene vrednosti je zabeležena in shranjena za obdobje 24 ur. Po izteku obdobja trajanja izjeme se vrednost povrne na izvorno nastavitvev in simbol »roke« izgine.	

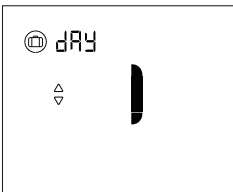

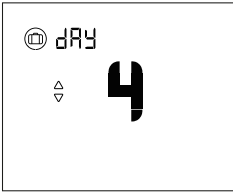

5.2 Nastavitev vrednosti preko enostavnega menija: Neposredna nastavitvena vrednost

Ukrep	Opis	Zaslona
1	Pritisnite  ali  .	
2	Nastavljena vrednost utripa. Nastavite vrednost s pomočjo gumbov  in  .	
3	Ko je nastavitvena vrednost izbrana, počakajte 5 sekund. Vrednost preneha utripati. Nastavljena vrednost je bila spremenjena.	

5.3 Način odsotnosti

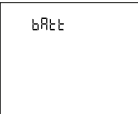
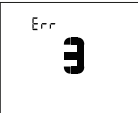
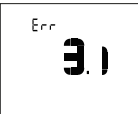
Ukrep	Opis	Zaslon
1	Pritisnite gumb  .	
2	Nastavite število dni v obdobju odsotnosti s pomočjo gumbov  in  .	
3	Počakajte 5 sekund. ☞ Izpiše se število preostalih dni v obdobju odsotnosti.	
	☞ Za preklic načina za odsotnost ponovno pritisnite gumb  .	

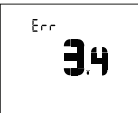
6 Seznam napak

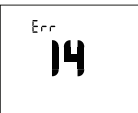
Št.	Opis napake	Ukrepi
	Če je napolnjenost <10 %, je prisotna okvara baterij.	Zamenjajte bateriji
	Napaka senzorja temperature	Prosimo, obrnite se na vašega serviserja.
	Prekinjen tokokrog	
	Vrednost pod spodnjo mejo	
	Vrednost nad zgornjo mejo	
	Kratek stik	
	Motnje v delovanju WiFi (če ni signala WiFi več kot 16 minut)	
	Neppravilno delovanje gumba (če je prisotnost napake na gumbu zaznana za dlje kot 20 sekund)	



Lined writing area consisting of multiple horizontal lines.



Ta oprema je v skladu z:

- Direktivo o nizki napetosti 2014/35/EU, ki ustreza standardu EN 60335-1,
- Direktiva o elektromagnetni združljivosti 2014/30/EU



Aparat je označen s tem simbolom. To pomeni, da morajo biti vsi električni in elektronski izdelki strogo ločeni od gospodinjstvih odpadkov.

V državah Evropske unije (*), Norveški, Islandiji in Lihtenštajnu je vzpostavljen poseben sistem za ločeno zbiranje tovrstnih izdelkov.

Izdelka ne poskušajte razstaviti sami. To lahko škodljivo vpliva na vaše zdravje in okolje.

Hladilno tekočino, olje in druge dele mora predelati usposobljeni monter v skladu z veljavnimi lokalnimi in nacionalnimi zakoni.

V primeru reciklaže mora to napravo predelati specializirana služba in se pod nobenim pogojem ne sme odvreči z gospodinjstvi odpadki, velikimi odpadki ali na odlagališče.

Za dodatne informacije se obrnite na vašega inženirja za ogrevanje ali servisno službo.

* Odvisno od nacionalnih predpisov posamezne države članice.

Datum dovoljenja za obratovanje:

Kontaktne podatke vašega inženirja za ogrevanje ali servisne službe.



atlantic-comfort.com

Société Industrielle de Chauffage

SATC - BP 64 - 59660 MERVILLE - FRANCE